

* 3 E R W 2 *

3	E	R	W	2
---	---	---	---	---

↑
請把電腦條碼貼在方格內
Please stick the barcode label in the box.

Education Bureau Territory-wide System Assessment 2023 Primary 3 English Language Reading & Writing

Instructions:

學生須知：

1. Stick barcode labels on pages 1, 3 and 5 in the spaces provided.
在第 1、3 及 5 頁的適當位置貼上電腦條碼。
2. There are 4 parts in this Question-Answer Booklet.
Answer all questions.
本卷共有 4 部分，全部題目均須作答。
3. Do not write in the margins.
請勿在框線以外書寫。
4. Time allowed is 30 minutes.
評估時限為 30 分鐘。
5. Write your School Code, Class and Class Number in the boxes below.
在下面的方格內填寫學校編號、班別及班號。

Instructions for answering questions:

作答說明：

Multiple Choice Questions – Blacken the circle next to the correct answer with an **HB pencil**. For example:

選擇題 – 選出正確的答案，並用 **HB 鉛筆** 把該選項的圓圈塗黑和塗滿，如：

- | | | | | |
|-------------------------------------|----|-------------------------------------|--|--------------------------|
| <input checked="" type="radio"/> A. | | <input checked="" type="radio"/> A. | | <input type="radio"/> B. |
| <input type="radio"/> B. | or | <input type="radio"/> C. | | <input type="radio"/> D. |
| <input type="radio"/> C. | 或 | <input type="radio"/> C. | | |
| <input type="radio"/> D. | | | | |

Other Questions – Write your answers in the spaces provided.

其他題目 – 在適當的位置內填寫答案

School Code
學校編號

P			
---	--	--	--

Class
班別

3	
---	--

Class No.
班號

--	--

↑
此格只許填寫一個大楷英文字母
Write one capital letter in this box.

Part 1

Mark is reading a menu in a restaurant.

Read the menu.



GINA'S KITCHEN

Cheese burger \$20	Egg sandwich \$12	Mushroom pizza \$22
Chicken burger \$25	Ham sandwich \$18	Seafood pizza \$35
Beef burger \$30		

Super hotdog \$35
On Saturdays only!



Lemon tea	\$6
Coffee	\$7
Orange juice	\$11

**Open:
Monday - Sunday
8 am - 10 pm**

Choose the best answer by blackening the circle.

- Mark can go to the restaurant on Mondays at _____.

<input type="radio"/> A. 6 am	<input type="radio"/> B. 7 am
<input type="radio"/> C. 9 am	<input type="radio"/> D. 11 pm

- Mark can buy a super hotdog on _____.

<input type="radio"/> A. Mondays	<input type="radio"/> B. Wednesdays
<input type="radio"/> C. Saturdays	<input type="radio"/> D. Sundays

請把電腦條碼貼在方格內
Please stick the barcode label in the box.



3. Mark buys a chicken burger. He pays _____.
- A. \$18 B. \$20
- C. \$22 D. \$25
4. There is/are _____ kind(s) of pizza on the menu.
- A. one
- B. two
- C. three
- D. four
5. Mark has \$15. He can have a/an _____.
- A. egg sandwich
- B. ham sandwich
- C. beef burger
- D. seafood pizza

Please do not write in the margin. 請勿在此書寫。

Please do not write in the margin. 請勿在此書寫。

Part 2

Mark is writing a letter to his teacher Mr Wong.

Read the letter.

	7 th June 20XX	1
Dear Mr Wong,		
I love going to school. I like Chinese, Maths and Music but my favourite subject is English.		
I feel happy in your lessons. You play games with us and tell us funny stories. We ask many questions but you don't get angry. At recess, you talk to us like a friend.		5
My dad sometimes reads your notes in my workbooks and exercise books. <u>He</u> thinks you are a good English teacher.		10
Thank you!		
	Your student, Mark	

Choose the best answer by blackening the circle.

1. Who writes the letter?

- | | |
|----------------------------------|--|
| <input type="radio"/> A. Mark | <input type="radio"/> B. Mark's dad |
| <input type="radio"/> C. Mr Wong | <input type="radio"/> D. the Maths teacher |

2. Mark's favourite subject is _____.

- | | |
|----------------------------------|----------------------------------|
| <input type="radio"/> A. Chinese | <input type="radio"/> B. English |
| <input type="radio"/> C. Maths | <input type="radio"/> D. Music |

請把電腦條碼貼在方格內
Please stick the barcode label in the box.

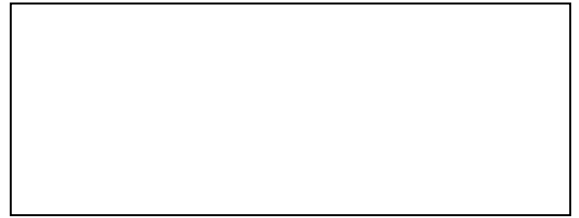

3. Mark feels _____ in Mr Wong's lessons.

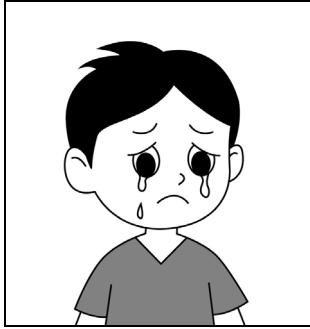

A.

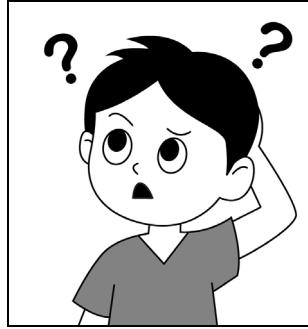

B.

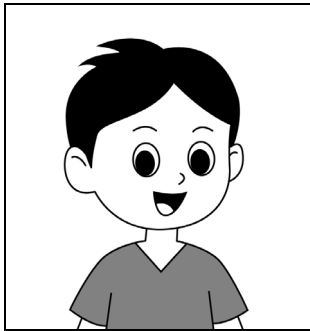

C.

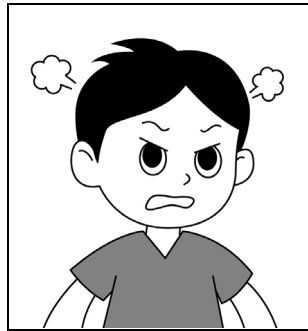

D.

4. In the lessons, Mr Wong likes to _____.

- A. use workbooks and tell stories
- B. play games and use exercise books
- C. use workbooks and exercise books
- D. play games and tell stories

5. At recess, Mark talks to _____.

- A. Mr Wong
- B. his father
- C. his Chinese teacher
- D. his Maths teacher

Please do not write in the margin. 請勿在此書寫。

Please do not write in the margin. 請勿在此書寫。

6. Mark's father sometimes _____.
- A. reads stories B. talks to Mr Wong
- C. teaches Mark D. reads Mr Wong's notes
7. Read line 9. The word 'He' refers to _____.
- A. Mark B. Mark's dad
- C. Mr Wong D. the Music teacher

Part 3

Mark is reading a story.

Read the story.

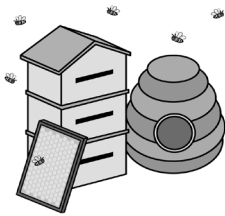

Tom and the Bees



Tom loves birds, fish and butterflies but he is afraid of bees.

One school holiday, he visits Aunt Mary's farm. It is a beautiful, quiet place. Aunt Mary shows Tom some wooden boxes. Tom sees many bees in the boxes and screams loudly. Everyone on the farm can hear him.

Aunt Mary says, "Bees are helpful. They make honey in the boxes." She gives Tom a spoon of honey. "It tastes sweet," she says. "It's healthy too." Aunt Mary gives him a jar of honey and a book about bees to take home.

Now Tom knows bees are good for the Earth because they help plants to grow. They are our friends. He sees the bees on the farm every weekend and he loves them.

Choose the best answer by blackening the circle.

1. At the beginning of the story, Tom is afraid of _____.

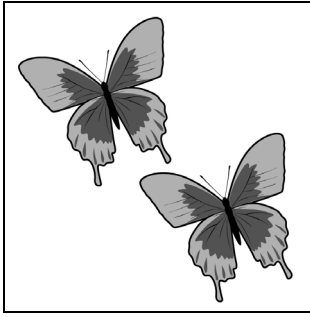

A.

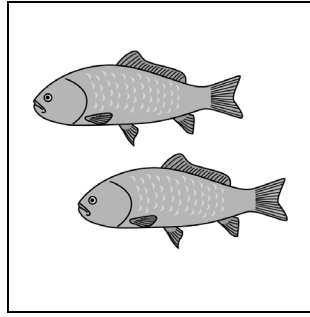

B.

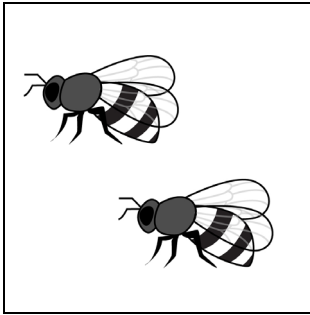

C.

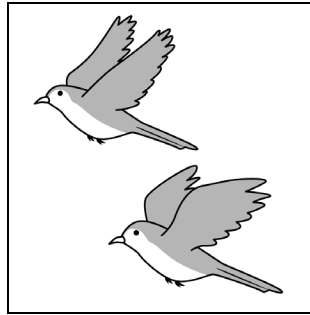

D.

2. One school holiday, Tom visits a _____.

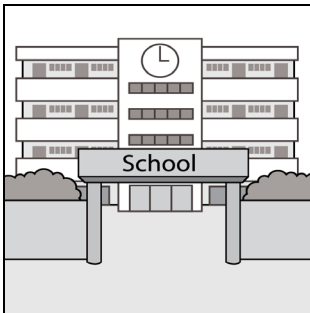

A.

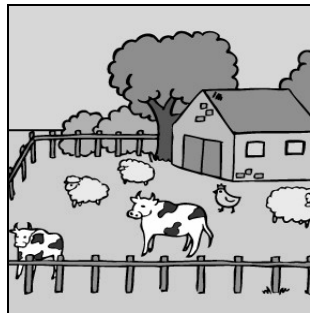

B.

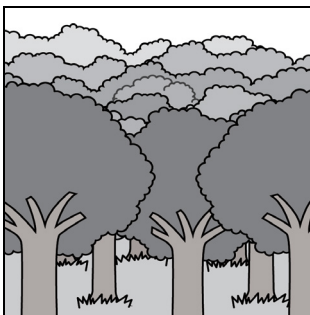

C.

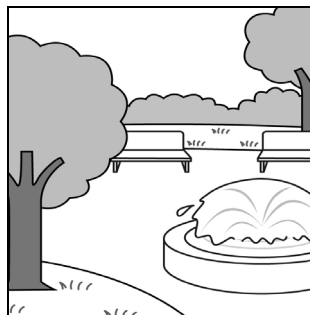

D.

3. Read line 6. The word 'screams' means _____.

- A. visits
- B. tastes
- C. shows
- D. shouts

4. Aunt Mary thinks honey is _____.

- 1) beautiful
- 2) healthy
- 3) unhealthy
- 4) sweet

- A. 1 and 2
- B. 2 and 4
- C. 3 and 4
- D. 1 and 3

5. Aunt Mary gives Tom a _____ of honey to take home.

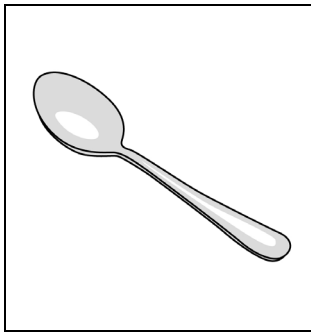

A.

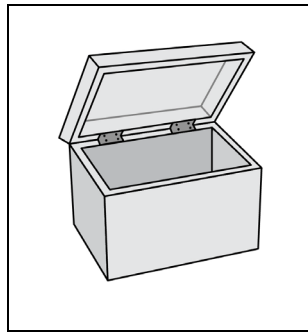

B.

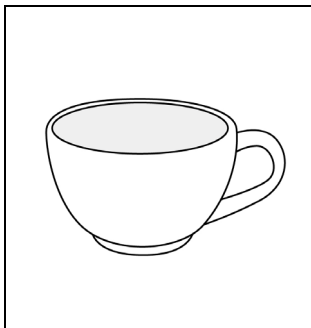

C.

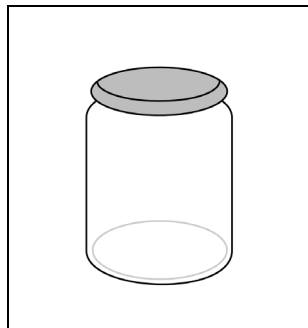

D.

6. Read lines 12 – 14. Why are bees good for the Earth?

- A. They help plants to grow.
- B. They live on a farm.
- C. They are birds' friends.
- D. They are lovely.

7. At the end of the story, Tom visits the farm _____.

- A. at weekends
- B. on school holidays
- C. when he is not afraid
- D. when he needs honey

8. Read line 14. The word 'them' refers to _____.

- A. the plants
- B. the boxes
- C. the bees
- D. Aunt Mary and Tom

Part 4

Anna is writing a letter to her friend Betty about her favourite toy.

You are Anna. Write the letter in about 30 words.

You may use the following questions and pictures to help you. You may also use your own ideas.

- ◆ What is it?
- ◆ What does it look like?
- ◆ Where do you put it?
- ◆ When do you play with it?
- ◆ Why do you like it?

e.g.

teddy bear



e.g.

toy plane

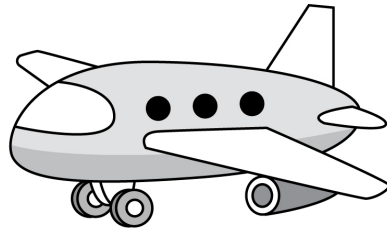

Please do not write in the margin. 請勿在此書寫。

7th June 20XX

Dear Betty,

How are you? Let me tell you about my favourite toy.

Your friend,
Anna

END OF PAPER

Please do not write in the margin. 請勿在此書寫。

